







PRODUCT SPECIFICATION				PART NUMBER: VTD192	REV. A	 A UNIT OF  CORPORATION	
				MODEL NUMBER: DBM60-101	DATE: 3-26-10	BENTON HARBOR, MI U.S.A. P.O. Box 97 Ph: 269-926-6171 Fax: 269-925-8288	
<47 d(B)A	°C	20-80	7.0 kg.				
V	A	W	Hz				
120	1.7	63	60				

NOTES:

1. PRODUCT DIMENSIONS: ALL DIMENSIONS ARE REFERENCE ONLY.
2. TECHNICAL DATA SUBJECT TO CHANGE WITHOUT NOTICE.

PERFORMANCE

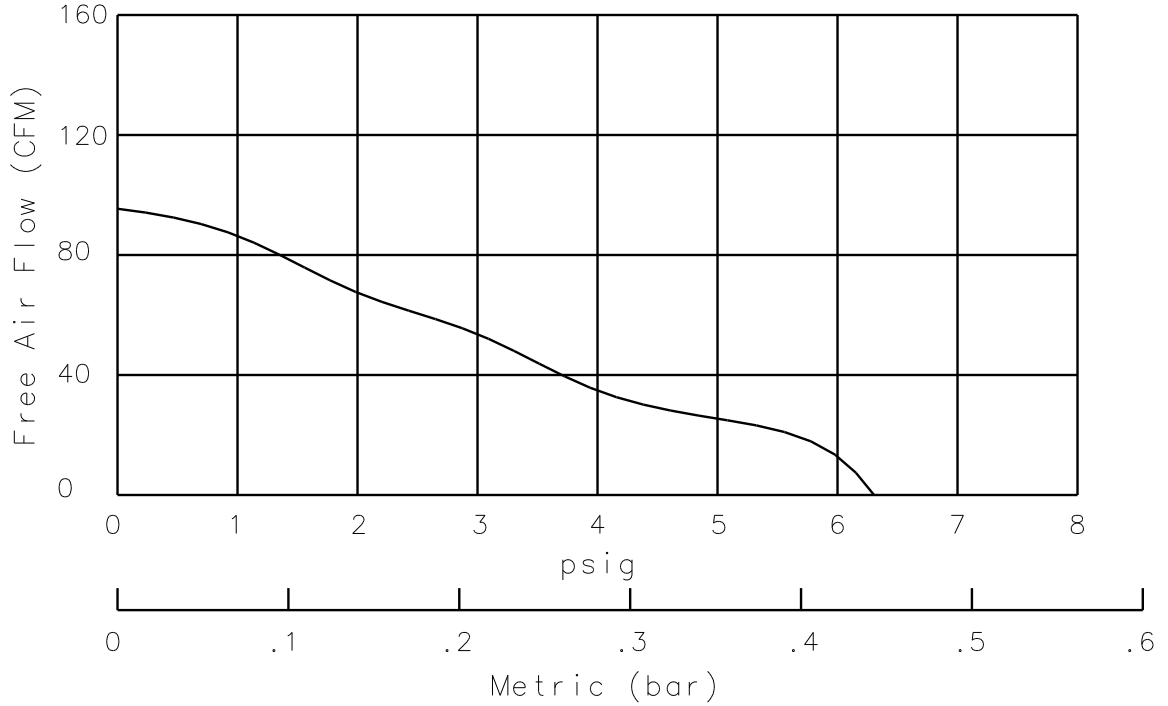

DIMENSIONS (mm)

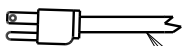
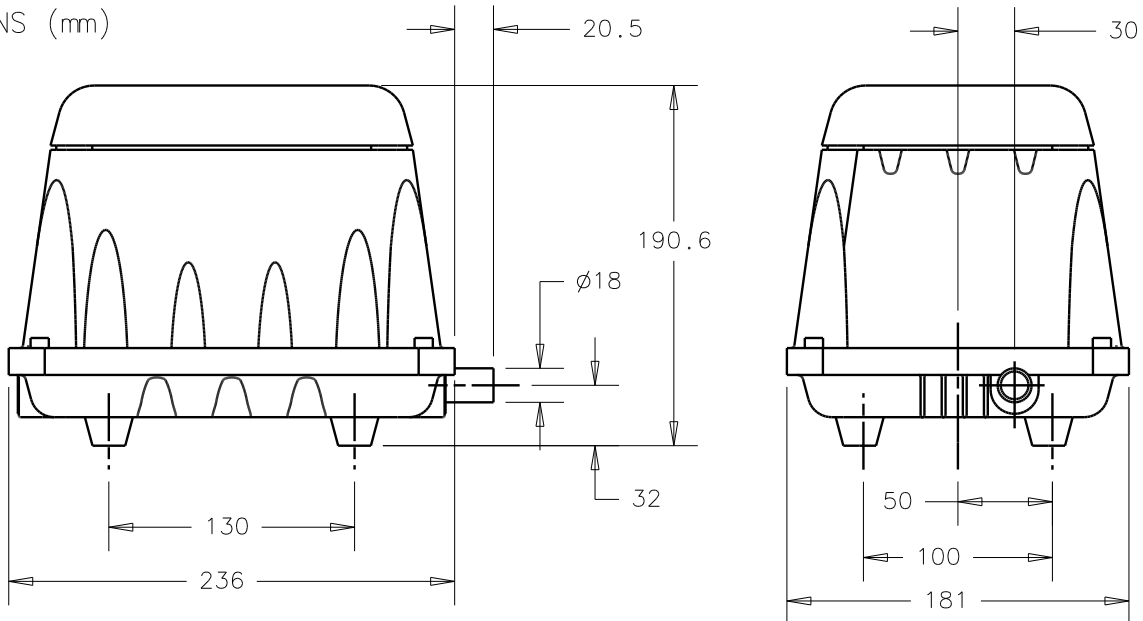

3 CORE PVC CABEL